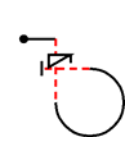
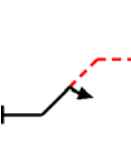
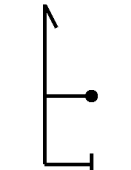
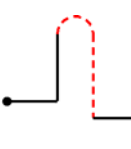
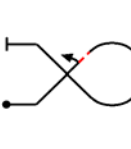
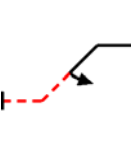
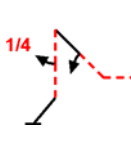
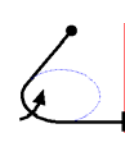

2. Unknown

Advanced

Pilot ID #

Flight #

No	Symbol	Catalog No	K	Tot K	Score	Remarks
1		8.34.3 9.11.1.4	13 5	18		
2		1.3.4 9.1.4.2	7 6	13		
3		5.1.1	17	17		
4		8.3.1	15	15		
5		7.20.1 9.1.2.2	14 9	23		
6		1.3.3 9.1.4.2	8 6	14		
7		1.15.2 9.1.2.2 9.1.5.1	14 9 3	26		
8		2.3.1	19	19		

Item	K	Score
Positioning		
Harmony		
PENALTIES	Interruptions	
	Insertions	
	Too high	
	Too low	
	Outs	
	Other	
	Disqual Fig #	
T/O time		
End time		

Fig K
<b>145</b>

Total K

Judges Details
Signature
Name
Number



Olan v6.0 © M. Golan http://www.aerobatics.org.il/olan

Pilot

A/C



No	Catalog No	K	Tot K
1	8.34.3	13	18
	9.11.1.4	5	sf 3
2	1.3.4	7	13
	9.1.4.2	6	sf 7
3	5.1.1	17	17
4	8.3.1	15	sf 7
5	7.20.1	14	23
	9.1.2.2	9	sf 7
6	1.3.3	8	14
	9.1.4.2	6	sf 7
7	1.15.2	14	26
	9.1.2.2	9	sf 7
	9.1.5.1	3	sf 7
8	2.3.1	19	sf 2

---Total K= 145 ---

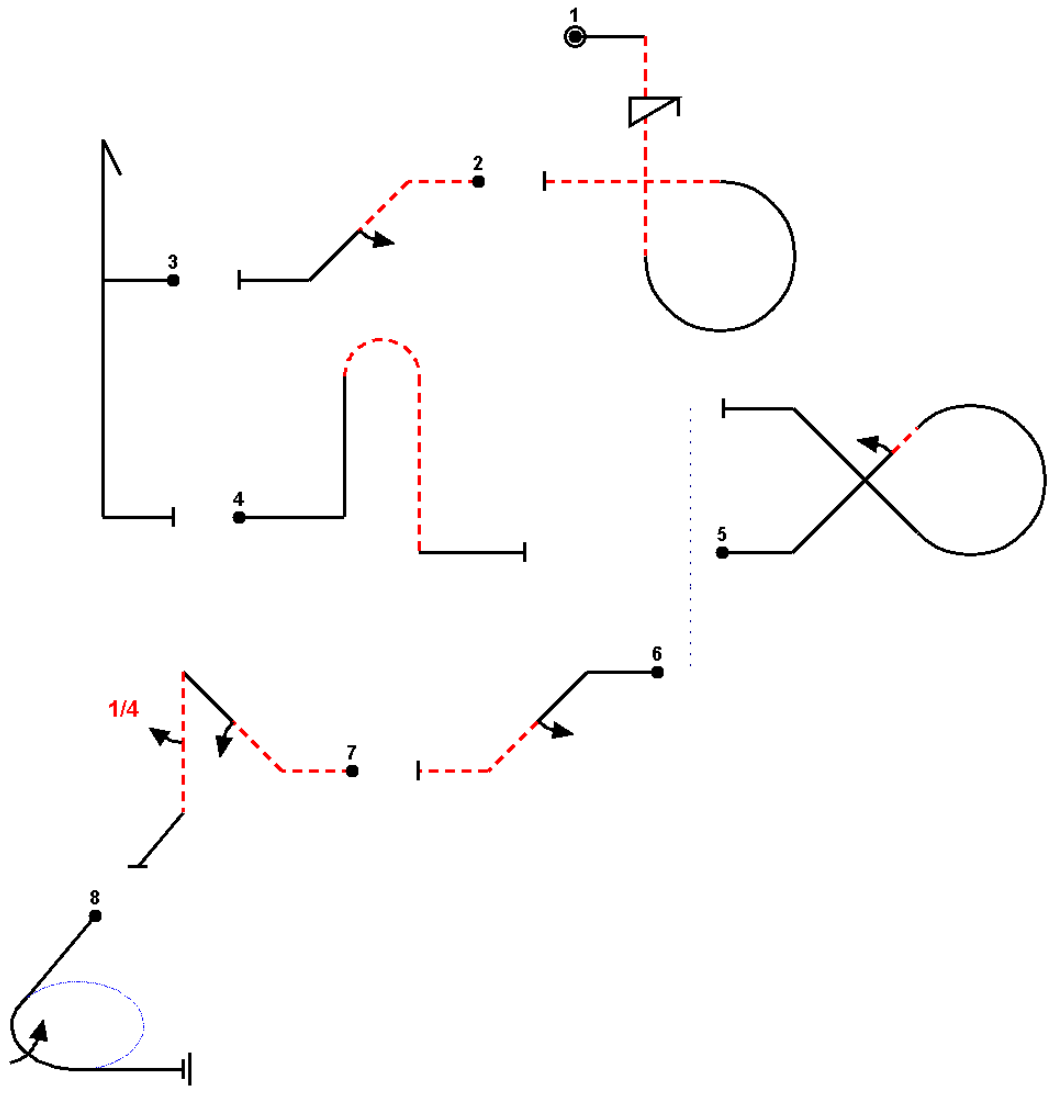

Total K = 145 (13k@2,26k@7)

Olan v6.0 © M. Golan <http://www.aerobatics.org.il/olan>

\_\_\_\_\_  
pilot

\_\_\_\_\_  
A/C



Deutsche Meisterschaften		2011	FORM C
Pilot ID #	2. Unknown	Advanced	Flight #

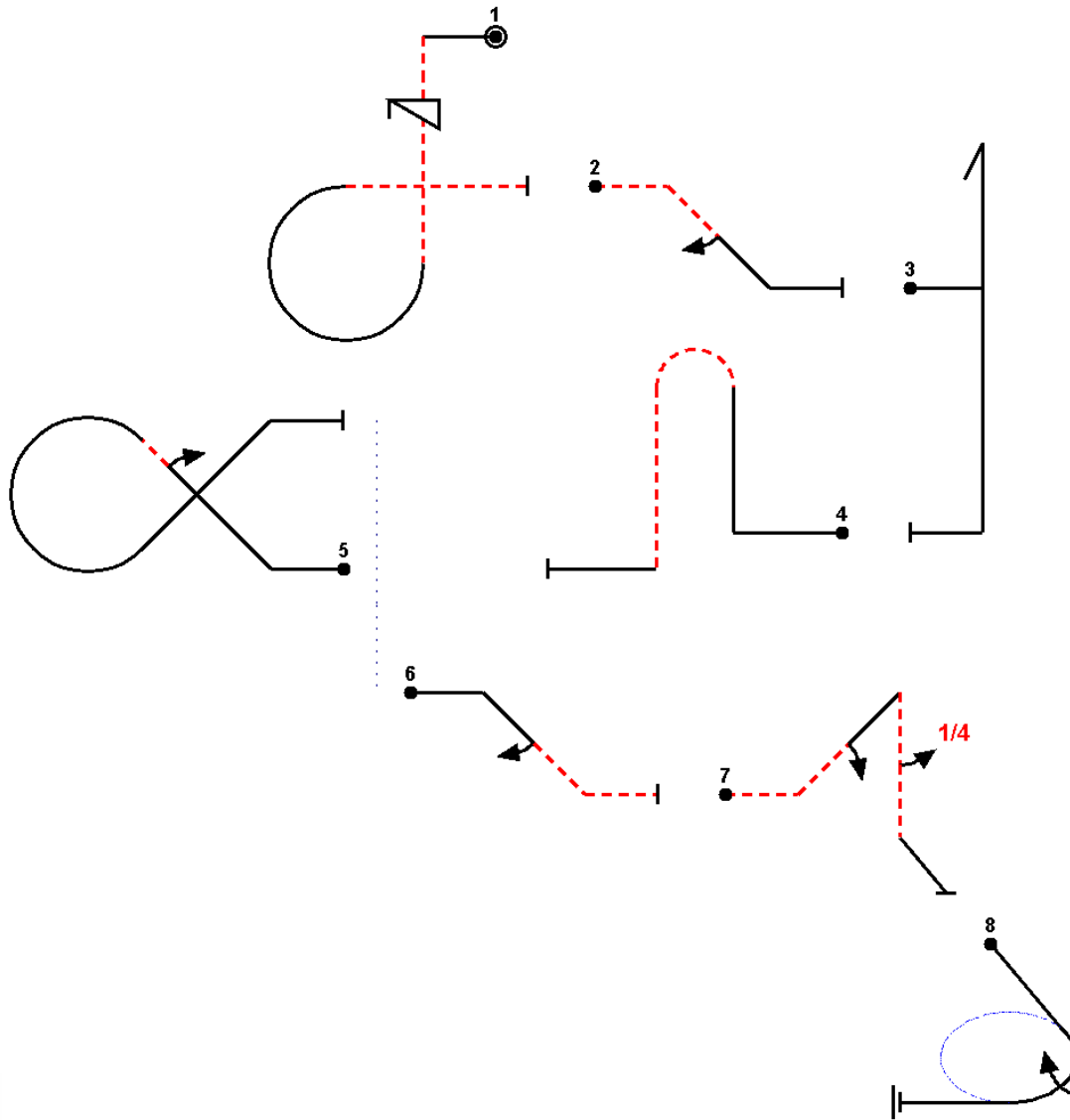

Total K = 145 (13k@2,26k@7)

Olan v6.0 © M. Golan <http://www.aerobatics.org.il/olan>

2011 Verification Rules unavailable to verify sequence: 11 civa-glider:advanced.2.  
sirp- -id2 h pb2g id2- -2t4 1j1

